

SB[®] 755 Wide



More room to move and care



The popular **SB 755** from Invacare is now available in wider variants of 1050 mm and 1200 mm, providing even more comfort for taller or bigger clients (weights of 200 kg). These wider models provide extra space and comfort for larger clients and plenty of room to turn. The **SB 755 Wide** has been engineered with a sophisticated auto-regression system to offer total comfort. The bed also offers an optimal seating position and is designed to reduce shear and friction. The **SB 755 Wide** is attractive and modern, whilst the streamlined design is easy to clean and will blend harmoniously into any homecare or institutional environment.



Comfort for users and carers

The **SB 755 Wide** comes with several key features designed to ensure an excellent sitting position and to reduce shear and friction during movement. As Invacare always strives to cater for all needs, we are delighted to now offer an integrated length extension of 100 mm at the head and foot of the bed to meet the requirements of taller users.

Safety is key

As always at Invacare, safety is our key concern. Side rails in both the standard bed length and the extendable version meet the increased strength demands of the IEC 60601-2-52 standard for beds, without compromising the ergonomics or working conditions of the carers.

More room to move and care

The additional width offered by the **SB 755 Wide** is particularly beneficial for clients who require additional space for comfort, whilst reducing the risk of back injury to the carer. The **SB 755 Wide** lowers to a 350mm entry height which allows independent users to transfer in and out of bed, reducing the manual handling risk of the carer.

Features and options



Auto regression – improved functionality. Increased comfort when activating backrest, minimising shear and friction forces.

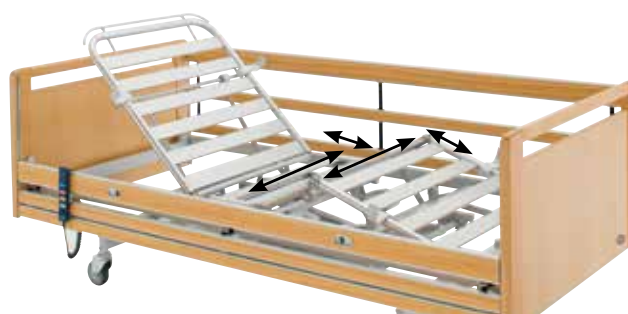

Optimised dimensions of mattress platform according to anthropometrical measurement, for increased comfort.



Extendable mattress platform. Additional 100 mm at head and foot. Bed easily extends with 50, 100, 150 or 200 mm to suit clients needs.



Line Side rail

Full-length side rail meets the strength and safety demand of the IEC 60601-2-52 bed standard. The Line side rail is lightweight and easy to use.



Line Extendable side rail

Full-length side rail, which can be adjusted incrementally from 2000-2200 mm.

Features and options



Swivel support handle

The swivel support handle provides good support for the client getting to a standing position.

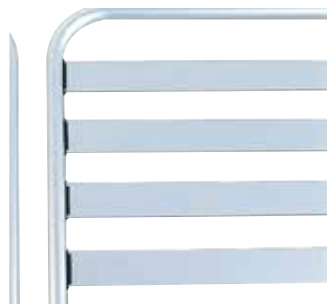

Mattress support

Mattress support with aluminium slats.

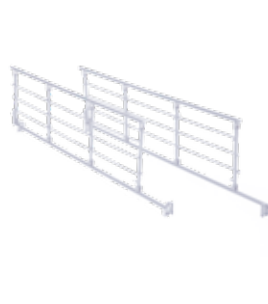

Invacare **Scala Basic 2**

Foldable steel side rail.

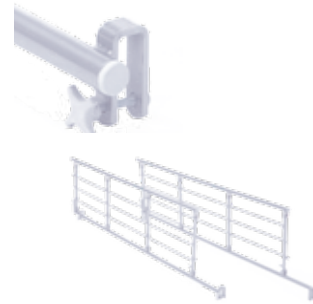

Invacare **Scala Basic Plus 2**

Foldable steel side rail with plastic inserts at the mounting brackets.

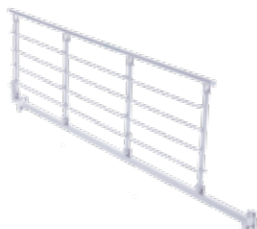

Invacare **Scala Medium 2**

Foldable steel side rail for higher mattresses.

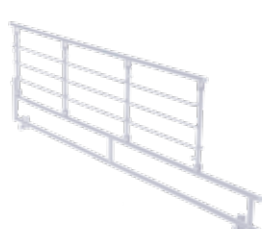

Invacare **Scala Decubi 2**

Foldable steel side rail for extra high mattresses.



Central brake

Available as standard.



Lowering kit

Using castors of 75 mm creates a lower height of 250 mm.



Cover for wooden side rail

Padded cover for wooden side rails. Cover remains in place when side rail is lowered.



Several hand controls

Invacare **Soft Control** or standard with "green" auto profile button function.



Lifting pole

The handle can be adjusted both in height and depth.

Technical data

For more comprehensive pre-sales information about this product, including the product's user manual, please visit www.invacare.co.uk.

	Width outside Width inside	Length outside Length inside	Height adjustment	Mattress support dimensions	Under bed clearance	Backrest angle	Thigh angle	Minimum angle below horizontal
SB 755 Wide 1050 mm	1150 mm 1050 mm	2130mm 2080mm Mattress:2000mm	350-820 mm Total height: 1600-2070mm	800 - 260 - 260 - 680 mm	150 mm	0 - 73°	0 - 28°	0 - 16°
SB 755 Wide 1200 mm	1300 mm 1200 mm	2130mm 2080mm Mattress:2000mm	350-820 mm Total height: 1600-2070mm	800 - 260 - 260 - 680 mm	150 mm	0 - 73°	0 - 28°	0 - 16°

	Legrest lift	Angle below/ above frame	Max. user weight
SB 755 Wide	0 - 18°	below: 25° above: 14°	SWL 235 kg 200 kg

Frame colour and wood work

Aluminium grey

Beech

Light oak

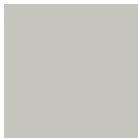

Please note
colours may
vary slightly
from those
displayed left.



Complies with IEC 60601-2-52.

NB:

The bed must not be used by patients under 12 years of age, or by patients with body size equivalent to an average 12 year old or smaller.

Warranty

5 years frame
5 years actuator
5 years control box
2 years hand control

The *Invacare SB755* is part of the Safe Patient Handling range.



Safe
Patient
Handling

Invacare Limited
Pencoed Technology Park - Pencoed
Bridgend CF35 5AQ - United Kingdom
Tel: +44 1 656 776 222
Fax: +44 1656 776 220
E-mail: uk@invacare.com
Sales Order E-mail: ordersuk@invacare.com
www.invacare.co.uk

Invacare Ireland Ltd
Unit 5 - Seatown Business Campus
Seatown Road - SWORDS
County Dublin - Ireland
Tel. +353 1 8107084
Fax +353 1 8107085
Email: Ireland@invacare.com
www.invacare.ie

